

Contents



IMPORTANT SAFETY INSTRUCTIONS

Read all instructions before using this appliance.

Save these instructions for future reference.

This guide contains important safety symbols and instructions. Please pay attention to these symbols and follow all instructions given. Here is a brief explanation of the use of these symbols.

⚠ WARNING This symbol will help alert you to situations that may cause serious bodily harm, death or property damage.

⚠ CAUTION This symbol will help alert you to situations that may cause bodily injury or property damage.

Destroy the carton and plastic bags after unpacking the range. 
Never allow children to play with packaging material.

Install only per
installation instructions provided in the literature package for
this range.
Ask your dealer to recommend a qualified technician and an
authorized repair service. Know how to disconnect the power to
the range at the circuit breaker or fuse box in case of an
emergency.

All other servicing should be done only by a qualified technician,
This may reduce the risk of personal injury and damage to the
range.

⚠ WARNING

- All ranges can tip.
- Injury to persons could result.
- Install anti-tip device packed with range.
- See Installation Instructions.

anti-tip bracket provided with the range. To
check if the bracket is installed properly, visually
check that rear leveling leg is inserted into and
fully secured by the anti-tip bracket by
removing lower panel or storage drawer. For
models with a warmer drawer, grasp the top
edge of the range and carefully attempt
to tip it forward. Refer to the Installation
Instructions for proper anti-tip bracket
installation.

Do not allow children to climb or
stand on top of the range. The weight of a child on an open door may
result in serious burns or other injury.

IMPORTANT SAFETY INSTRUCTIONS

IMPORTANT INSTRUCTIONS FOR USING YOUR COOK TOP

Place a pan of food on the unit before turning it on, and turn the unit off before removing the pan.

—This appliance is equipped with one or more surface units of different sizes. Select utensils having flat bottoms large enough to cover the surface unit heating element. The use of undersized utensils will expose a portion of the heating element to direct contact and may result in ignition of clothing. Proper relationship of utensil to element will also improve efficiency.

—To reduce the risk of burns, ignition of flammable materials, and spillage due to unintentional contact with the utensil, the handle of the utensil should be positioned so that it is turned inward, and does not extend over adjacent surface units.

—Boilovers cause smoking and greasy spillovers that may ignite, or a pan that has boiled dry may melt.

Heating elements should never be immersed in water. Heating elements clean themselves during normal operation.

—Only certain types of glass, glass/ceramic, ceramic, earthenware, or other glazed utensils are suitable for cook top service without breaking due to the sudden change in temperature. Check the manufacturer's recommendations for cook top use.

FOR COIL COOK TOP MODELS

—Absence of these pans or bowls during cooking may subject wiring or components underneath to damage.

—Do not use aluminum foil to line surface unit drip bowls, or reflector pans. Only use aluminum foil as recommended in this manual. Improper installation of these liners may result in risk of electric shock, or fire. Improper installation of these liners may result in risk of electric shock, or fire.

IMPORTANT INSTRUCTIONS FOR USING YOUR OVEN

—Stand to the side of the range when opening the door of a hot oven. Let hot air or steam escape before you remove or replace food in the oven.

The oven vent is located under the left rear surface element if your model is equipped with coil elements. The oven vent is located below the backguard for models equipped with ceramic-glass cook tops. Touching the surfaces in this area when the oven is operating may cause severe burns. Also, do not place plastic or heat-sensitive items on or near the oven vent. These items could melt or ignite.

Always place oven racks in desired location while oven is cool. If rack must be moved while oven is hot use extreme caution. Use potholders and grasp the rack with both hands to reposition. Do not let potholders contact the hot heating elements in the oven. Remove all utensils from the rack before moving.

The broiler pan and its insert allow dripping fat to drain and be kept away from the high heat of the broiler.

—Do not use aluminum foil to line the oven bottom. Only use aluminum foil as recommended in this manual. Improper installation of these liners may result in risk of electric shock, or fire. Improper installation of these liners may result in risk of electric shock, or fire.

IMPORTANT INSTRUCTIONS FOR CLEANING YOUR RANGE

Pay particular attention to the area underneath each surface element. Do not allow grease to accumulate.

Be aware that excess residue from cleaners and aerosols may ignite causing damage and injury.

Follow manufacturer's instructions for cleaning.

SELF CLEANING OVENS

Before self cleaning the oven, remove the broiler pan and any utensils or foods from the oven.

—No commercial oven cleaner or oven liner protective coating of any kind should be used in or around any part of the oven.

—The door gasket is essential for a good seal. Care should be taken not to rub, damage or move the gasket.

- The health of some birds is extremely sensitive to the fumes given off during the self-cleaning cycle of any range. Move birds to another well-ventilated room.

Before Setting Oven Controls

Oven Vent Location

the left rear surface element
below the backguard.

under

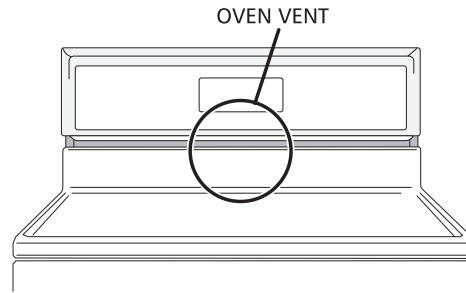

Arranging Oven Racks

ALWAYS ARRANGE OVEN RACKS WHEN THE OVEN IS COOL (PRIOR TO OPERATING THE OVEN).

REMOVING & REPLACING OVEN RACKS

To remove
To replace

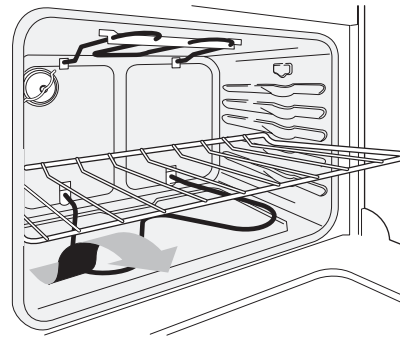

ARRANGING OVEN RACKS WITH 5 RACK POSITIONS

To bake on 1 rack

To bake on 2 racks,

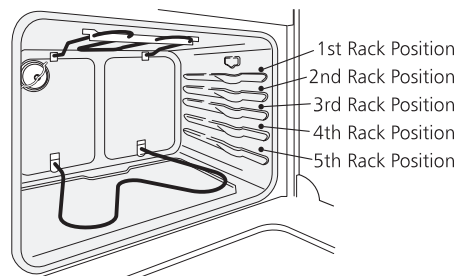

Control Pad Functions

READ THE INSTRUCTIONS CAREFULLY BEFORE USING THE OVEN.

CLEAR PAD

UP and DOWN ARROW PADS

CLOCK PAD

CLEAR

BAKE PAD

FEATURE INDICATOR LIGHTS

BROIL PAD

CLEAN PAD

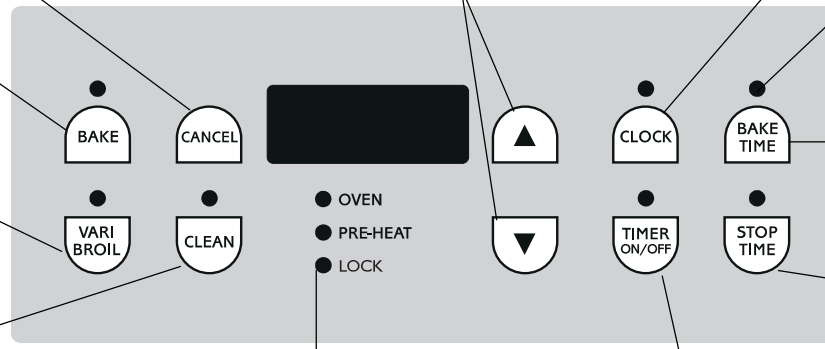

BAKE TIME PAD

STOP TIME PAD

OVEN, PREHEAT & LOCK LIGHTS
light

"OVEN"
"PREHEAT"

TIMER PAD

TIME BAKE

"LOCK" light

The oven can be programmed to:

For a silent control panel:



Note:

Temperature conversion:

To change the temperature to °C (Celsius) or from °C to °F (control should not be in a Bake or Clean mode):

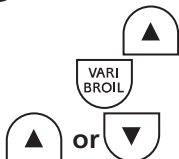

Setting the Clock and Minute Timer

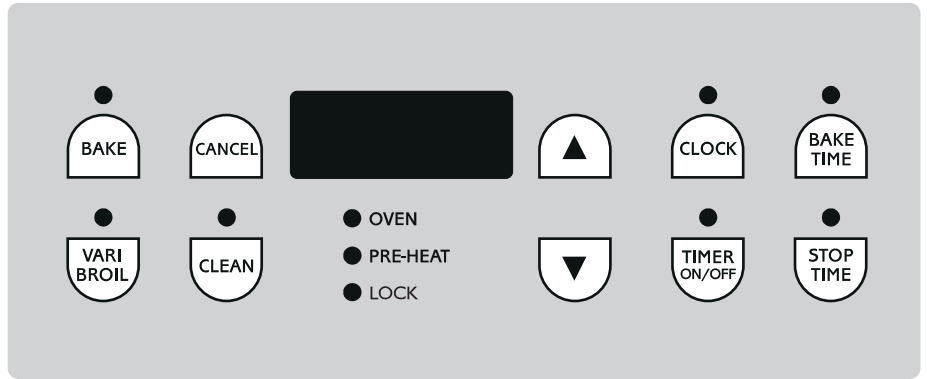

To Set the Clock - Control Style 4



Note:

Note:

To Set the Minute Timer - Control Style 4



Note:



Note:

To Change the Minute Timer while it is in use:



To Cancel the Minute Timer before the set time has run out:



Setting Oven Controls

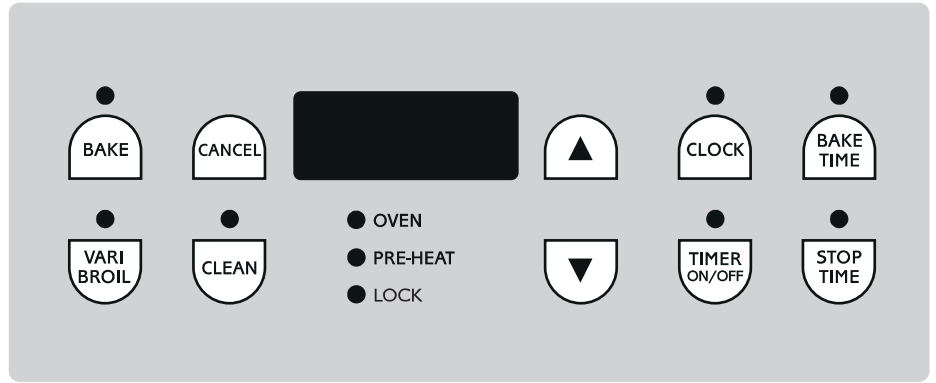

Note

Note

To Set or Change the Temperature for Normal Baking

To Set the Controls for Normal Baking:

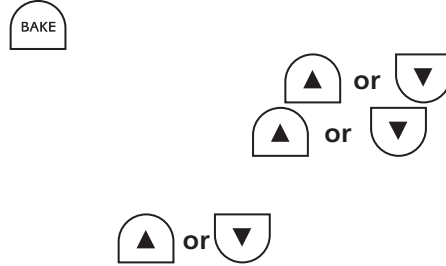

To Change the Oven Temperature after Baking has Started:



Setting Oven Control

Benefits of Speed Bake™ Cooking System:

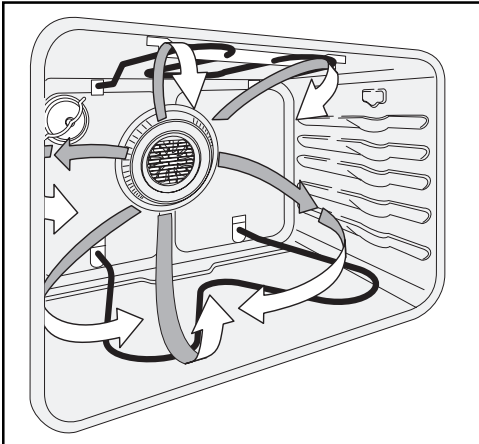

Recommended Foods for Speed Bake™ Cooking System

Food Item	Decrease Cook Time by:

SPEED BAKE

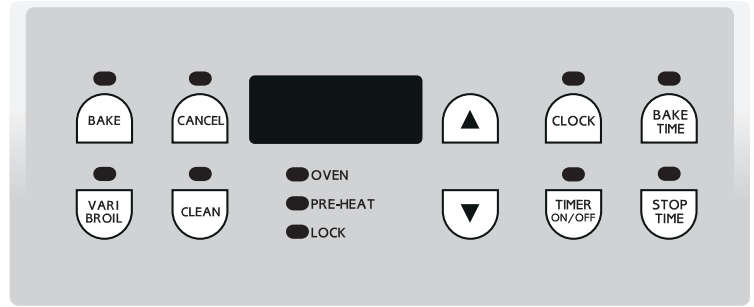

Speed Bake™ Cooking System - (If equipped)

Speed Bake™ Cooking System

Speed Bake™ Cooking System

Speed Bake™ Cooking System

General Cooking Instructions:

Speed Bake

Speed Bake

Speed Bake,

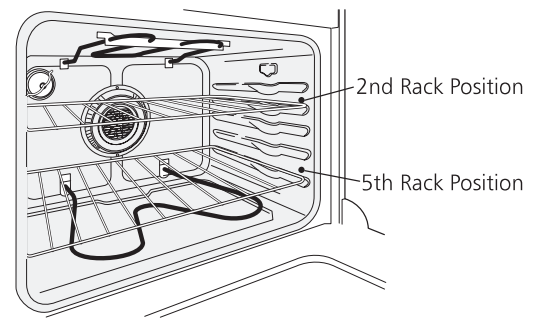

To Set Speed Bake™ Cooking System:

Speed Bake

CANCEL

NOTE:

Setting Oven Control

To Set the Automatic Timer (Timed Bake Feature)

BAKE TIME STOP TIME

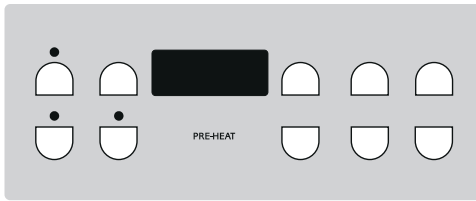

To Program the Oven to Begin Baking Immediately and To Shut Off Automatically:

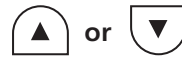
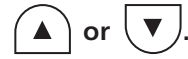

CAUTION

To Program Oven for a Delayed Start Time and to Shut-Off Automatically

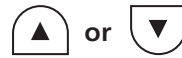
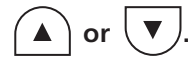

NOTE:

Speed Bake



Once the Controls are Set:

When the Set Bake Time Runs Out:



To Change the Oven Temperature or Bake Time after Baking has Started:



Setting Oven Controls

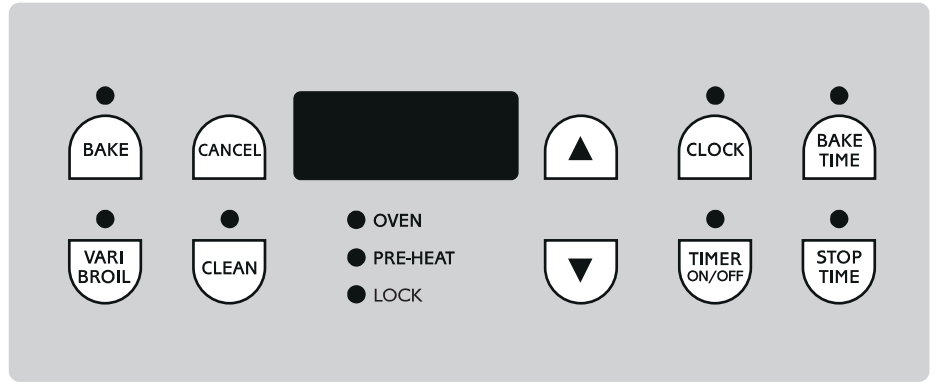

To Broil

Rack Position From Top	Food

DO NOT
DO NOT

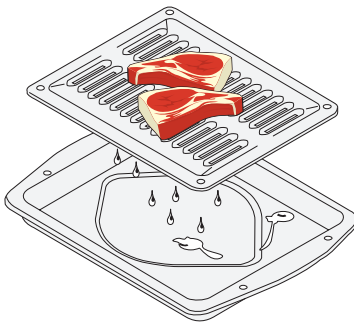

DO NOT

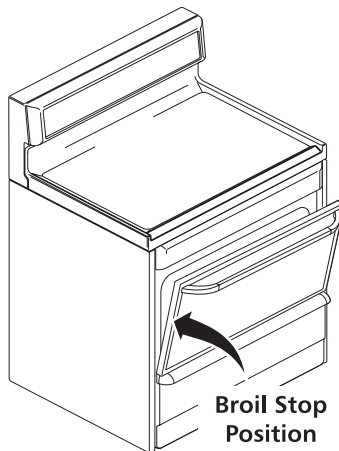

Broil Stop
Position

Open the oven door to the broil stop position when broiling.

Note:



CAUTION

DO NOT

NOTE: DO NOT

Speed Bake

Speed Bake

Self-Cleaning

Self-Cleaning Oven

Self-Cleaning

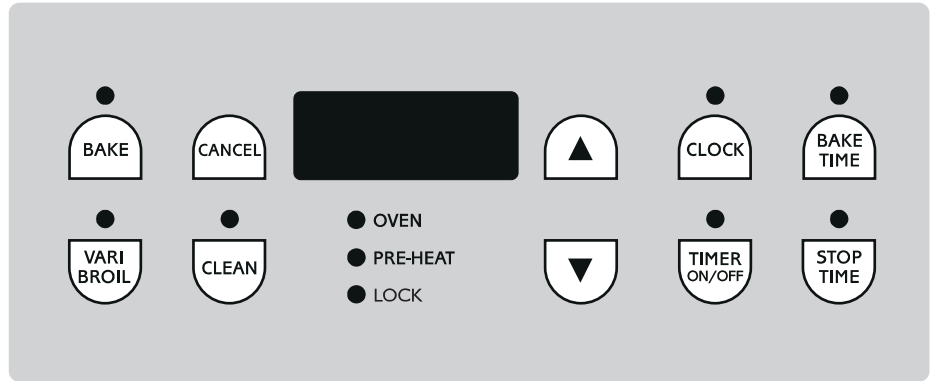

CAUTION

CAUTION DO NOT

To Start the Self-Clean Cycle

* light soils
average to heavy soils

To Set the Controls for a Self-Clean Cycle:

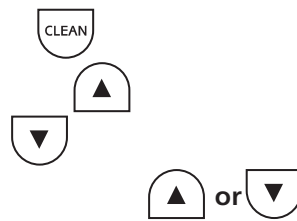

DO NOT

When the Self-Clean Cycle is Completed:

CANCEL or CLEAR

Stopping or Interrupting a Self-Cleaning Cycle

CLEAR

General Cleaning

Cleaning Various Parts of Your Range

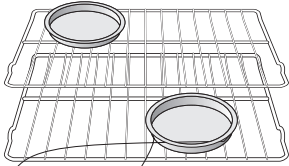
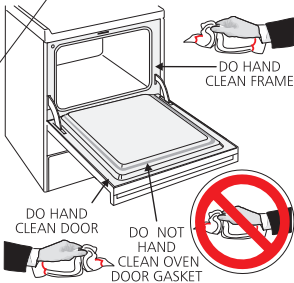
Surfaces	How to Clean
Aluminum (Trim Pieces) & Vinyl	
Glass, Painted and Plastic Control Knobs, Body Parts, and Decorative Trim	<p><i>For general cleaning and built-up grease</i></p> <p style="text-align: right;"><i>For more difficult soils</i> DO NOT</p>
Stainless Steel, Chrome Control Panel, Decorative Trim	<p><i>Before cleaning the control panel,</i></p>
Porcelain Enamel Broiler Pan and Insert, Door Liner, Body Parts, Warmer Drawer (if equipped)	<p style="text-align: right;"><i>If necessary</i></p> <p style="text-align: right;">DO NOT</p>
<p>Oven Racks</p> 	
<p>Oven Door</p>  <p>DO HAND CLEAN FRAME</p> <p>DO HAND CLEAN DOOR</p> <p>DO NOT HAND CLEAN OVEN DOOR GASKET</p>	<p style="text-align: center;">DO NOT</p> <p style="text-align: right;">DO NOT</p>



Changing Cooktop and/or Oven Lights

(if equipped)

CAUTION

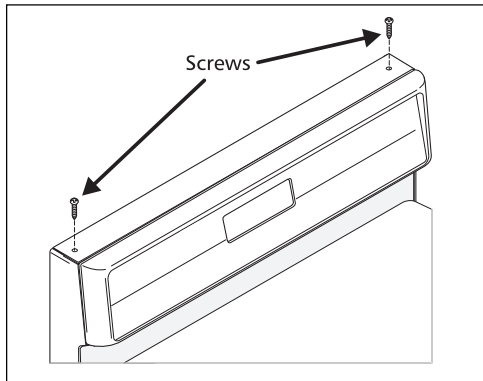

To Change the Cooktop Light (some models)

To Change the Oven Light (some Self Cleaning Models)

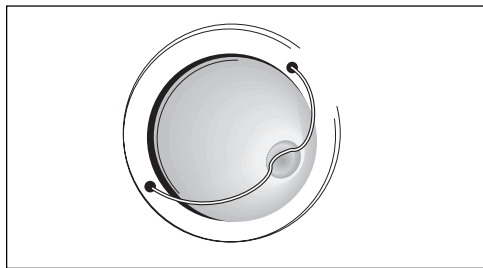

To replace the oven light:

Clock and Minute Timer

Setting the

Customizing Your Oven Performance

Note:

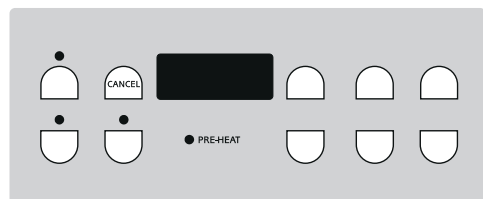

To Adjust Oven Temperature



Avoid Service Checklist

Before you call for service,

OCCURRENCE

POSSIBLE CAUSE/SOLUTION

Range is not level.

Cannot move appliance easily.
Appliance must be accessible for service.

Surface element too hot or not hot enough.

Surface element does not heat.

Avoid Service Checklist

General Cleaning

Entire appliance does not operate.

Cooktop and/or oven light (some models) does not work.

models)

Changing Cooktop and/or Oven Lights (some

Oven smokes excessively during broiling.

Setting Oven Controls

broil stop position.

Drip bowls are pitting or rusting.

Drip bowls turning color or distorted.

DO NOT

*Oven control beeps continuously with no indicator lights flashing. (If model is equipped with a display, F1 or F3 will show.)

*

CANCEL

CANCEL

Poor baking results.

Adjusting Oven Temperature

Self-cleaning cycle does not work.

Oven Cleaning.

Oven Cleaning

Soil not completely removed after self-cleaning cycle.

Flames inside oven or smoking from vent.

Oven Cleaning

Drip bowls are pitting or rusting.

Drip bowls turning color or distorted.

DO NOT





MISSISSAUGA

L5P-4G2
LEAD ONE YEAR
WARRANTY

On

LIMITED 2ND
YEAR WA
(G)

...ates of the
...all warranties
...is warranted by V

...roducts North America
...8
...30917